

Gruppi Lavabo/ Washbasin Taps

MEMORY MIX

.EMIX430D

Miscelatore monocomando

Single lever tap



Prima di realizzare l'impianto
consultare la scheda Cod.
16024 e 16018

Before installing consult the
technical sheet Cod. 16024
and 16018

Agape srl

via A. Pitentino, 6 46037 Governolo
Roncoferraro (MN), Italy

T +39 0376 250311 / F +39 0376 250330

e-mail: info@agapedesign.it

www.agapedesign.it

.EMIX430D		2/5
COD.	VERS.	
202131	20211112	

CONTENUTO DELLA CONFEZIONE
PACKAGE CONTENTS

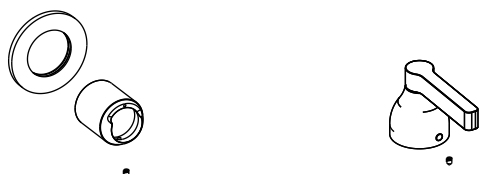

UTENSILI NECESSARI
NECESSARY TOOLS

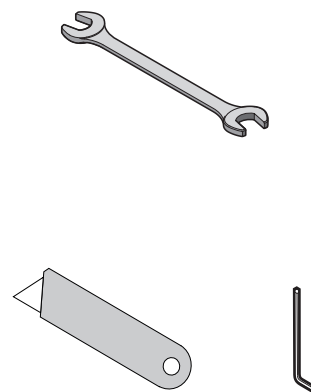

PREDISPOSIZIONE
PREPARATION



INSTALLATO
INSTALLED

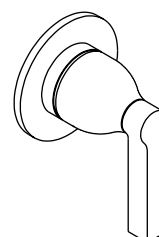

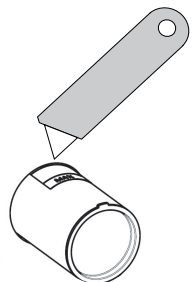
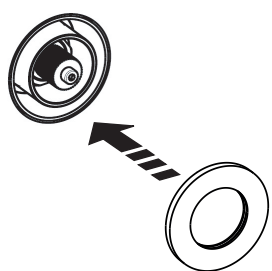
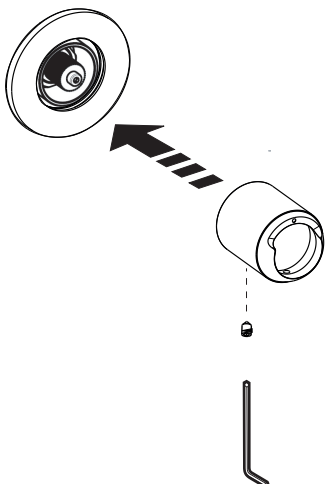
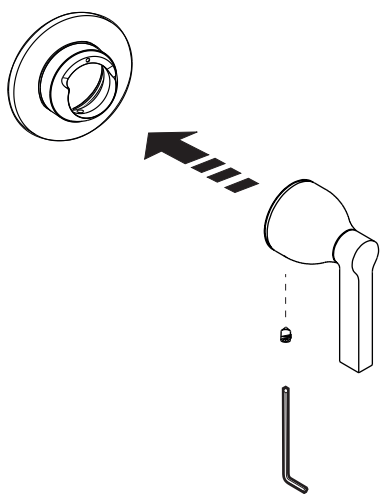
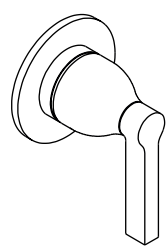
<p>1</p> 	<p>2</p> 
<p>3</p> 	<p>4</p> 
<p>5</p> 	<p>6</p> 

ISTRUZIONI DI UTILIZZO
INSTRUCTIONS FOR USE

- (IT) Al primo utilizzo o dopo un lungo periodo di inutilizzo, non consumare il primo mezzo litro di acqua potabile erogata. Chiudere l'impianto idraulico in caso di prolungata assenza. Controllare periodicamente la tenuta.
- (EN) On first use or following prolonged periods of inactivity, do not use the first half-litre of drinking water dispensed. Shut off the plumbing system in the event of a long absence. Check the water-tightness regularly.

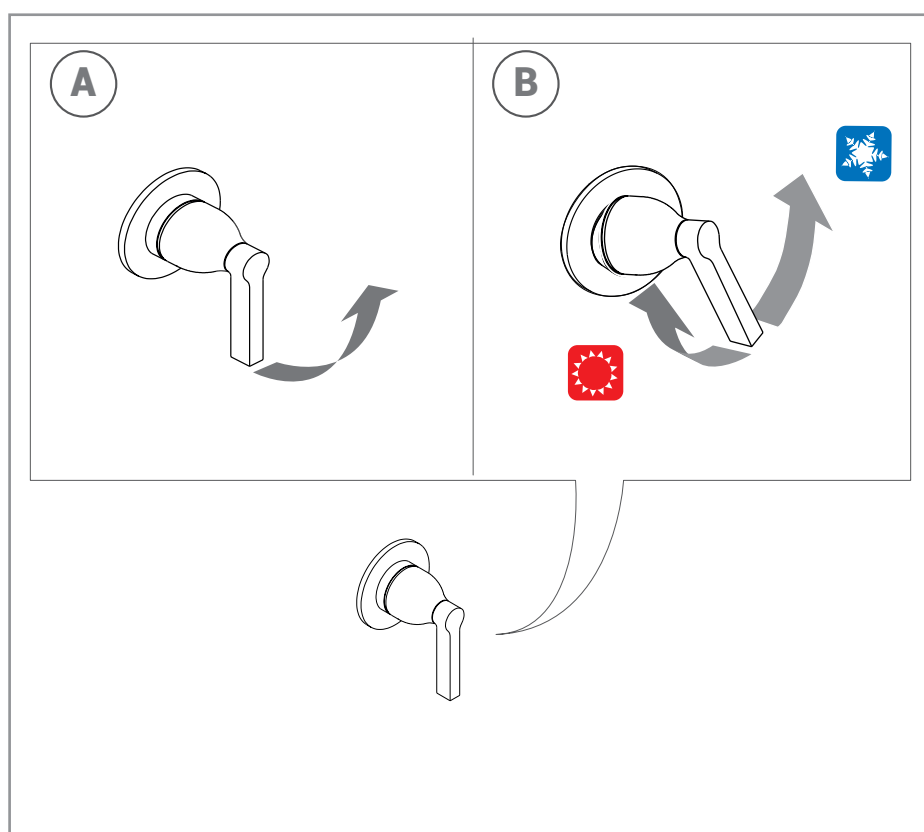

ELIX430D

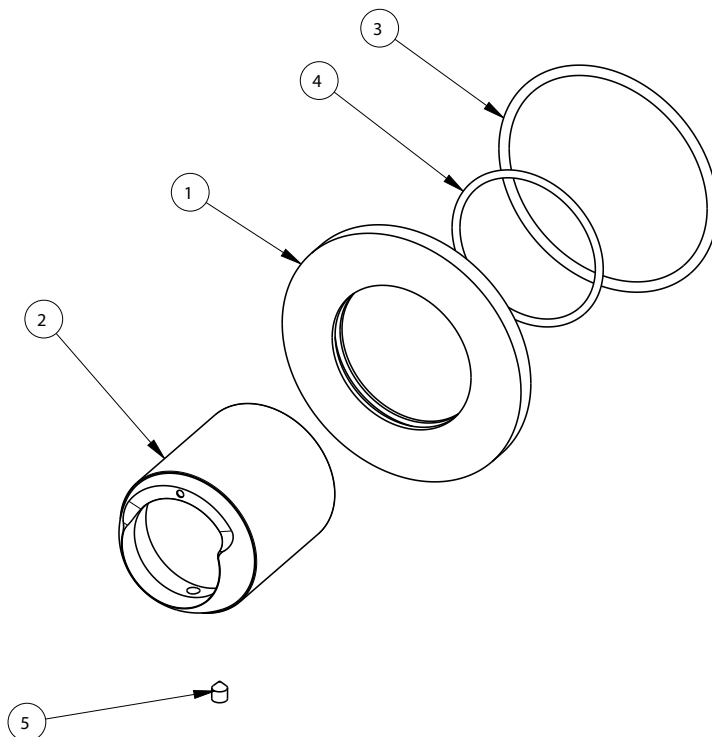

MANMIX01

