

| | |
|--|--|
|  | Lavabo / Washbasin |
| | BJHON1 - OUTDOOR |
| | ACER1081EM |
| | Lavabo indipendente in predisposto per scarico a parete CementoSkin® Independent washbasin designed for wall drainage in CementoSkin® |

MANUTENZIONE

Per la manutenzione quotidiana è sufficiente pulire la superficie con acqua saponata o con comuni detersivi.

La superficie ha una buona resistenza alle macchie e all'attacco chimico, tuttavia alcune sostanze come inchiostro, cosmetici e tinte potrebbero lasciare alcune macchie che andranno rimosse con un sapone abrasivo, un sapone acido o un sapone solvente (secondo la sostanza macchiante), aiutandosi con una spugna. La tintura di iodio macchia la superficie in modo permanente. Evitare il contatto con acetone e trielina.

MAINTENANCE

For daily maintenance it is sufficient to clean the surface with soap water or common detergents.

The surface has a good resistance to stains and chemical agents, nonetheless some substances like ink, cosmetics and colorations could leave some stains which have to be removed with the help of abrasive soap, acid or solvent containing soaps (depending on the staining substance), and a sponge. Jodine tincture stains the surface.

Avoid contact with acetone and trichlorethylene.

Agape srl

via A. Pitentino, 6 46037 Governolo
 Roncoferraro (MN), Italy

T +39 0376 250311 / F +39 0376 250330

e-mail: info@agapedesign.it

www.agapedesign.it

CONTENUTO DELLA CONFEZIONE
PACKAGE CONTENTS

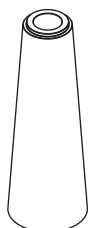
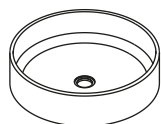

(A)



(B)



(C)



(F)



Feltro/Felt

STRUMENTI
TOOLS

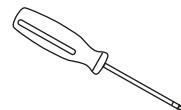
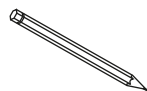

silicone

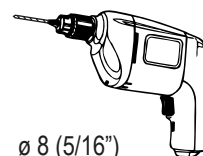

ø 8 (5/16")



sigillante polimerico per cemento
polymeric cement sealant

PREDISPOSIZIONE
WASHBASIN PREDISPOSITION

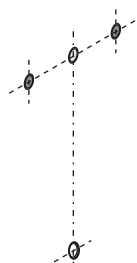

LAVABO INSTALLATO
WASHBASIN MOUNTED

RUBINETTO A PARETE
WALL MOUNTED TAP

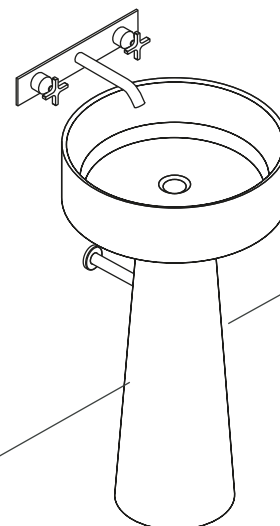

| | |
|---|--|
| <p>1</p> <p>X4</p> <p>ø 470 (18"1/2) lavabo/wasbas in</p> <p>ø 250 (9"13/16) colonna/column</p> | <p>2</p> <p>X4</p> <p>ø 8 (5/16")</p> <p>⚠</p> <p>Attenzione alla posizione dello scarico Attention to the position of the drain</p> |
| <p>3</p> <p>⚠</p> <p>silicone</p> <p>(B)</p> <p>(C)</p> <p>X4</p> | <p>4</p> |

| | |
|--|--|
| <p>5 Avvitare pileta e sotto-pileta Screw waste and counter waste</p> | <p>6 Per pavimenti con Moquette o su tappeti i feltri adesivi (F) non vanno applicati With carpet or carpet floors, adhesive felts (F) should not be applied</p> |
| <p>7 Applicare un adeguato strato di sigillante polimerico nell'angolo d'appoggio del lavabo. Apply an adequate amount of polymeric sealant in the support corner of the column.</p> | <p>8</p> <p>SE SERVE TAGLIARE LA PARTE IN ECCESSO / IF NECESSARY CUT THE PIPE TO LENGTH</p> |

9

Infilare lavabo sulla staffa facendo
coincidere il sifone col foro di scarico
Place the washbasin on the column
and insert the waste trap

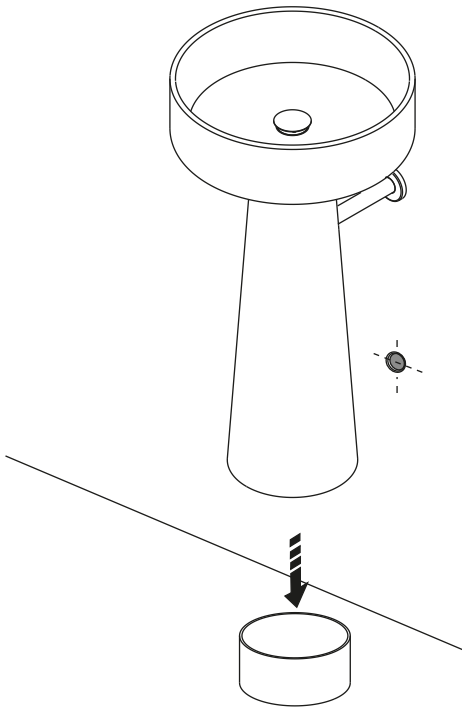

10

